

SPOT PROYECTOR

Diseño de calidad en aluminio puro, una solución de iluminación moderna, innovadora y versátil. Ideales para resaltar los elementos más atractivos de tus espacios, como fotografías, pinturas y más. Compatibles con bombillas **GU10** libremente intercambiables, optimizando el consumo energético. Montaje en riel y sobreponer.

LGR10R4BA2BB



Blanco	GU10 (NO INCLUIDO)	Aluminio	Riel
Ø54x110mm	Con adaptador de 4 cables	360° 90°	GARANTÍA 5 AÑOS KULENS

LGR10R4NA2NN



Negro	GU10 (NO INCLUIDO)	Aluminio	Riel
Ø54x110mm	Con adaptador de 4 cables	360° 90°	GARANTÍA 5 AÑOS KULENS

Compatible con lámparas GU10.
(Ver última hoja de la ficha técnica)

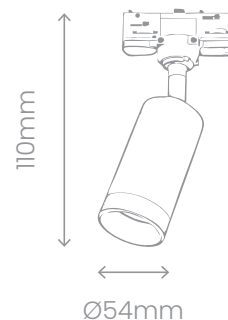

Luminario de sobreponer en techo con cabezal dirigible, diseñado para ofrecer máxima flexibilidad en iluminación de acento. Fabricado en aluminio de alta resistencia con acabado en pintura electrostática mate. Óptica de alta eficiencia disponible en ángulos de apertura de 36° y 60°, ideal para dirigir la luz con precisión. Alto confort visual garantizado y excelente reproducción de color.



LGR10NBA2BB

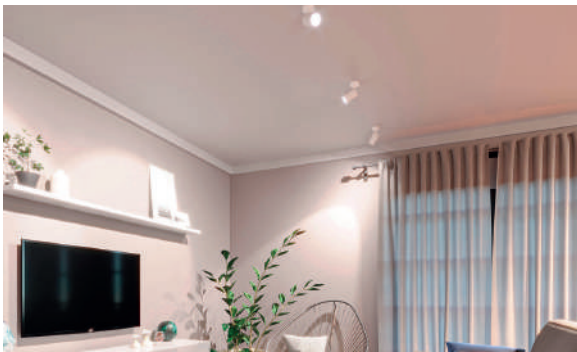

 Blanco	 GU10 (NO INCLUIDO)	 Aluminio	 Sobreponer
 Ø54x110mm	Con adaptador de 4 cables	 360° 90°	 GARANTÍA 5 AÑOS KULENS

LGR10NNA2NN



 Negro	 GU10 (NO INCLUIDO)	 Aluminio	 Sobreponer
 Ø54x110mm	Con adaptador de 4 cables	 360° 90°	 GARANTÍA 5 AÑOS KULENS

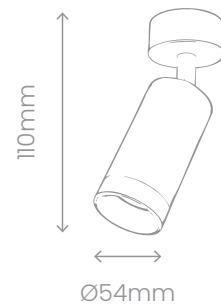







SPOT PROYECTOR

Av. Circunvalación Agustín Yáñez 1118, Col. Moderna, Guadalajara, Jal. C.P. 44190



LGR10SBA2BB



 Blanco	 GU10 (NO INCLUIDO)	 Aluminio
 Ø54x110mm	 Sobreponer	 GARANTÍA 5 AÑOS KULENS

LGR10SNA2NN



 Negro	 GU10 (NO INCLUIDO)	 Aluminio
 Ø54x110mm	 Sobreponer	 GARANTÍA 5 AÑOS KULENS

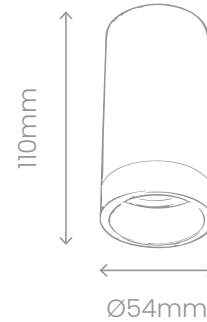

Diseñado para integrarse de forma sutil y elegante en cualquier espacio arquitectónico, este luminario de sobreponer en techo fijo proporciona una iluminación uniforme, de alta calidad y con un confort visual excepcional. Su diseño compacto lo convierte en una opción ideal para proyectos residenciales, comerciales y de hospitalidad donde la eficiencia, la estética y la funcionalidad son esenciales



SPOT PROYECTOR

Av. Circunvalación Agustín Yáñez 1118, Col. Moderna, Guadalajara, Jal. C.P. 44190



Este luminario dirigible de sobreponer ha sido cuidadosamente diseñado para ofrecer una solución de iluminación arquitectónica con un carácter sofisticado y contemporáneo. Fabricado en aluminio de alta calidad y disponible en acabados "premium", proporciona una luz uniforme y confortable, ideal tanto para iluminación general como de acento. Con un diseño atemporal y discreto, este luminario transforma la funcionalidad en una pieza de diseño.



LGR11SBB



 Blanco	 GU10 (NO INCLUIDO)	 Aluminio
 Ø56x158mm	 Sobreponer	 GARANTÍA 5 AÑOS KULENS

LGR11SNN



 Negro	 GU10 (NO INCLUIDO)	 Aluminio
 Ø56x158mm	 Sobreponer	 GARANTÍA 5 AÑOS KULENS

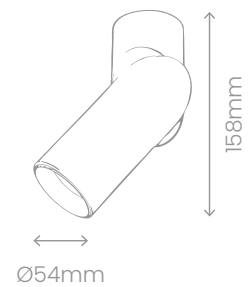

SPOT PROYECTOR

Av. Circunvalación Agustín Yáñez 1118, Col. Moderna, Guadalajara, Jal. C.P. 44190



LGR13SBB



 Blanco	 GU10 (NO INCLUIDO)	 Aluminio	 Sobreponer
 Ø54x110mm	Con adaptador de 4 cables	 360° 90°	 GARANTÍA 5 AÑOS KULENS

LGR13SNN

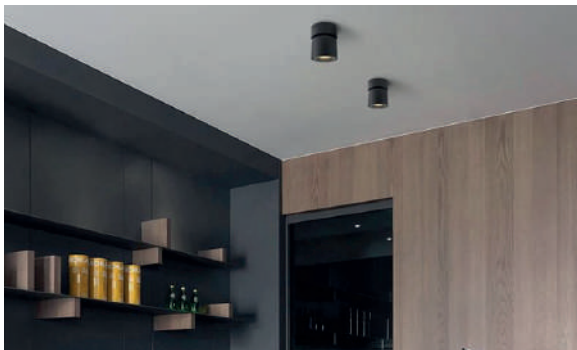

 Negro	 GU10 (NO INCLUIDO)	 Aluminio	 Sobreponer
 Ø54x110mm	Con adaptador de 4 cables	 360° 90°	 GARANTÍA 5 AÑOS KULENS

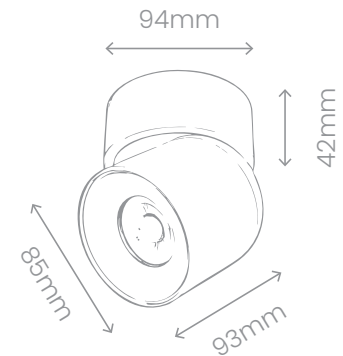

Este luminario de sobreponer en techo ha sido diseñado para ofrecer una iluminación precisa y flexible, adaptándose a las necesidades de cada espacio. Su cabezal dirigible permite orientar el haz de luz con libertad. Con ópticas de alta eficiencia y bajo índice de deslumbramiento, garantiza un confort visual superior y una excelente calidad de luz.

Su diseño limpio y contemporáneo combina funcionalidad, estética y tecnología de vanguardia.



SPOT PROYECTOR

Av. Circunvalación Agustín Yáñez 1118, Col. Moderna, Guadalajara, Jal. C.P. 44190



LÁMPARAS



Cuenta con tecnología CCT (selección de color), que permite ajustarla a las necesidades de cada espacio. Las lámparas **GU10** destacan por su eficiencia energética y versatilidad, ofreciendo un bajo consumo y una larga vida útil, lo que las convierte en una inversión inteligente a largo plazo. Además, están diseñadas para garantizar una conexión segura y estable, con una instalación sencilla y rápida."

GU1053CCTA38



Lumens	450 lm
Potencia	5W
Temperatura de color	3000K 4000K 6000K
Ángulo	38°
Medidas	Ø50xH56mm

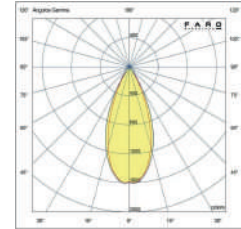

• Aplicaciones: Iluminación de acento en salas, vitrinas, pasillos, restaurantes y comercios.

GU1053CCTA60



Lumens	450 lm
Potencia	5W
Temperatura de color	3000K 4000K 6000K
Ángulo	60°
Medidas	Ø50xH56mm

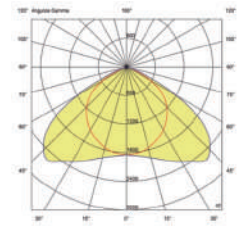

• Aplicaciones: Iluminación general en salas, cocinas, oficinas, pasillos, hoteles y comercios.

GU10505630KA120



Lumens	450 lm
Potencia	5W
Temperatura de color	3000K
Ángulo	120°
Medidas	Ø50xH56mm

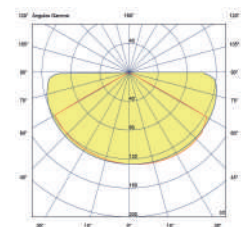

• Aplicaciones: Cubre grandes espacios, sin necesidad de muchas luminarias. Ideal para comercios, oficinas, hoteles y uso residencial.

