

Empotrados antideslumbrantes

Bisel de aluminio de alta calidad con reflector diseñado para minimizar el deslumbramiento directo. Compatible con lámparas GU10 para una mayor eficiencia energética

LGR06EB

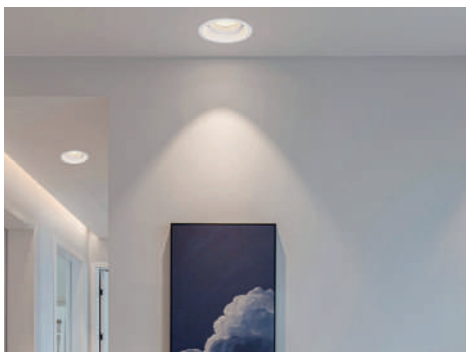

Blanco	GU10 (NO INCLUIDO)	Fundido en Alum.	IP20
Ø85mm	Ø75mm	25°	GARANTÍA 5 AÑOS KULENS

LGR06EN



Negro	GU10 (NO INCLUIDO)	Fundido en Alum.	IP20
Ø85mm	Ø75mm	25°	GARANTÍA 5 AÑOS KULENS

Compatible con lámparas GU10.
(Ver última hoja de la ficha técnica)

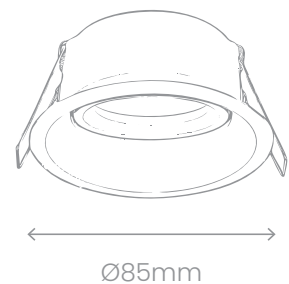

Con un diseño minimalista y sofisticado, esta luminaria dirigible de 25° redefine el confort visual en los espacios más exigentes. Su haz de luz preciso y controlado realza cada detalle con suavidad, reduciendo el deslumbramiento y elevando la calidad del ambiente. Perfecta para acentuar elementos arquitectónicos o crear atmósferas íntimas, combina flexibilidad, eficiencia y una estética impecable que transforma cualquier espacio en una experiencia visual única.

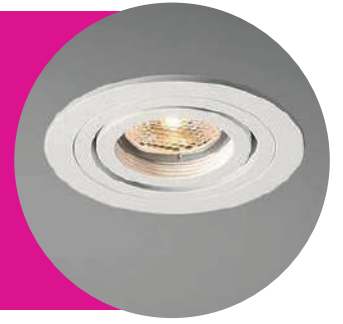

LGR23EB



 Blanco	 GU10 (NO INCLUIDO)	 Fundido en Alum.	 IP20
 Ø81x54mm	 Ø70mm	 25°	 GARANTÍA 5 AÑOS KULENS

LGR23EN



 Negro	 GU10 (NO INCLUIDO)	 Fundido en Alum.	 IP20
 Ø81x54mm	 Ø70mm	 25°	 GARANTÍA 5 AÑOS KULENS

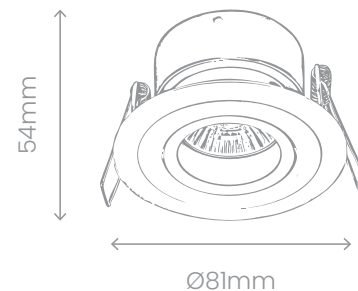

EMPOTRADOS ANTIDESLUMBRANTES

Av. Circunvalación Agustín Yáñez 1118, Col. Moderna, Guadalajara, Jal. C.P. 44190



LGR25EB



 Blanco	 GU10 (NO INCLUIDO)	 Fundido en Alum.	 IP20
 Ø92mm	 Ø80mm	 25°	 GARANTÍA 5 AÑOS KULENS

LGR25EN



 Negro	 GU10 (NO INCLUIDO)	 Fundido en Alum.	 IP20
 Ø92mm	 Ø80mm	 25°	 GARANTÍA 5 AÑOS KULENS

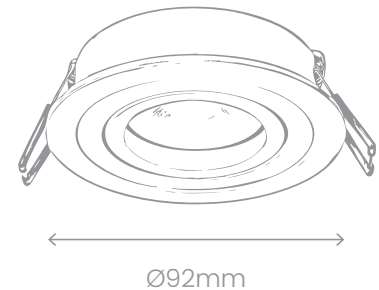

Este luminario empotrable dirigible ha sido diseñado para ofrecer una iluminación precisa y confortable. Su estructura permite orientar el haz de luz hacia puntos específicos, creando acentos sutiles o destacando elementos sin comprometer la estética del espacio. Combina tecnología de alto rendimiento, confort visual superior y un diseño elegante que se integra de manera discreta en cualquier proyecto de interiores residenciales, comerciales o de hospitalidad.



EMPOTRADOS ANTIDESLUMBRANTES

Av. Circunvalación Agustín Yáñez 1118, Col. Moderna, Guadalajara, Jal. C.P. 44190



Este luminario empotrable dirigible mezcla innovación y discreción para transformar cualquier espacio. Permitiendo destacar detalles o crear ambientes envolventes. se integra sin esfuerzo en techos modernos, aportando un toque de sofisticación y funcionalidad.

Ideal para proyectos que exigen luz de alta fidelidad, eficiencia energética y una estética atemporal.



LGR26EB

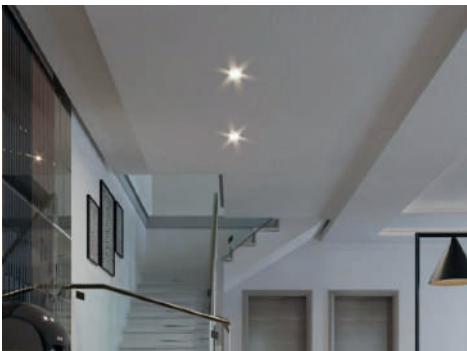

 Blanco	 GU10 (NO INCLUIDO)	 Fundido en Alum.	 IP20
 92x92x25mm	 80mm	 GARANTÍA 5 AÑOS KULENS	

LGR26EN



 Negro	 GU10 (NO INCLUIDO)	 Fundido en Alum.	 IP20
 92x92x25mm	 80mm	 GARANTÍA 5 AÑOS KULENS	

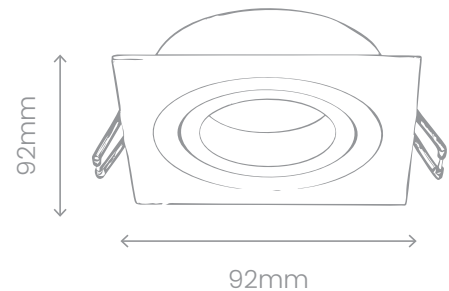

EMPOTRADOS ANTIDESLUMBRANTES

Av. Circunvalación Agustín Yáñez 1118, Col. Moderna, Guadalajara, Jal. C.P. 44190



LGR09EB



 Blanco	 GU10 (NO INCLUIDO)	 Fundido en Alum.	 IP20
 Ø95mm	 Ø80mm	 25°	 GARANTÍA 5 AÑOS KULENS

LGR09EN



 Negro	 GU10 (NO INCLUIDO)	 Fundido en Alum.	 IP20
 Ø95mm	 Ø80mm	 25°	 GARANTÍA 5 AÑOS KULENS

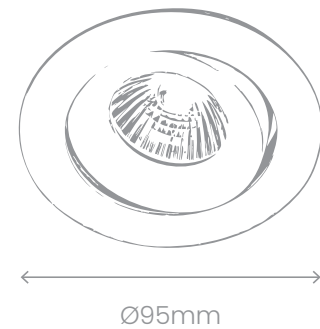

Este tipo de luminario, comúnmente utilizado para iluminación ambiental, se caracteriza por su diseño discreto y estética minimalista, lo que lo hace ideal para espacios modernos y elegantes. Este tipo de luminaria es ideal para resaltar detalles arquitectónicos o decorativos, aportando funcionalidad sin comprometer la estética del entorno.



EMPOTRADOS ANTIDESLUMBRANTES

Av. Circunvalación Agustín Yáñez 1118, Col. Moderna, Guadalajara, Jal. C.P. 44190



LÁMPARAS



Cuenta con tecnología CCT (selección de color), que permite ajustarla a las necesidades de cada espacio. Las lámparas **GU10** destacan por su eficiencia energética y versatilidad, ofreciendo un bajo consumo y una larga vida útil, lo que las convierte en una inversión inteligente a largo plazo. Además, están diseñadas para garantizar una conexión segura y estable, con una instalación sencilla y rápida."

GU1053CCTA38



Lumens	450 lm
Potencia	5W
Temperatura de color	3000K 4000K 6000K
Ángulo	38°
Medidas	Ø50xH56mm

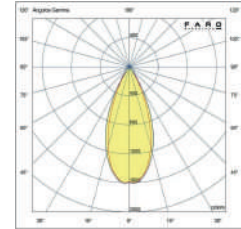

• Aplicaciones: Iluminación de acento en salas, vitrinas, pasillos, restaurantes y comercios.

GU1053CCTA60



Lumens	450 lm
Potencia	5W
Temperatura de color	3000K 4000K 6000K
Ángulo	60°
Medidas	Ø50xH56mm

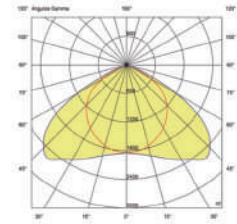

• Aplicaciones: Iluminación general en salas, cocinas, oficinas, pasillos, hoteles y comercios.

GU10505630KA120



Lumens	450 lm
Potencia	5W
Temperatura de color	3000K
Ángulo	120°
Medidas	Ø50xH56mm

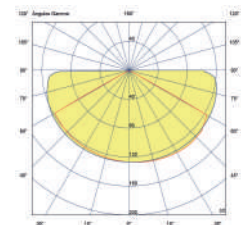

• Aplicaciones: Cubre grandes espacios, sin necesidad de muchas luminarias. Ideal para comercios, oficinas, hoteles y uso residencial.

