

## EXTERIOR ARBOTANTES

Colección de arbotantes para exteriores con tecnología LED y selección de temperatura de color. Su diseño atemporal y versatilidad los hacen ideales tanto para espacios residenciales como públicos. Con certificación IP65, garantizan resistencia a las condiciones climáticas, y sus diversos acabados permiten adaptarse a cualquier ambiente o concepto de iluminación.

### LGR15AB



 Blanco	 2 x GU10 (NO INCLUIDO)	 Aluminio	 Luz direccional
 Ø60x87x176mm	 Sobreponer	 IP65	 GARANTÍA 5 AÑOS KULENS

### LGR15AN



 Negro	 2 x GU10 (NO INCLUIDO)	 Aluminio	 Luz direccional
 Ø60x87x176mm	 Sobreponer	 IP65	 GARANTÍA 5 AÑOS KULENS

Compatible con lámparas GU10.  
(Ver última hoja de la ficha técnica)

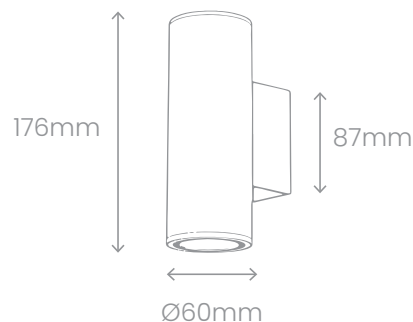

Ideales para fachadas, jardines, patios y entradas principales, los arbotantes no solo mejoran la visibilidad y seguridad en exteriores, sino que también aportan un toque de estilo, ya sea moderno, clásico o rústico, dependiendo del diseño seleccionado.



### LGR16AB



 Blanco	 GU10 (NO INCLUIDO)	 Aluminio	 Luz direccional
 Ø80x68x80mm	 Sobreponer	 IP65	 GARANTÍA 5 AÑOS KULENS

### LGR16AN



 Negro	 GU10 (NO INCLUIDO)	 Aluminio	 Luz direccional
 Ø80x68x80mm	 Sobreponer	 IP65	 GARANTÍA 5 AÑOS KULENS

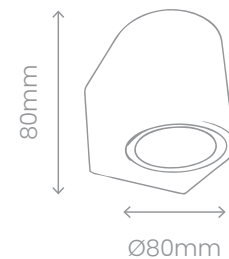

## EXTERIOR ARBOTANTES

Av. Circunvalación Agustín Yáñez 1118, Col. Moderna, Guadalajara, Jal. C.P. 44190



## LGR17AB



 Blanco	 2 x GU10 (NO INCLUIDOS)	 Aluminio	 Luz bidireccional
 Ø80x68x150mm	 Sobreponer	 IP65	 GARANTÍA 5 años KULENS

## LGR17AN

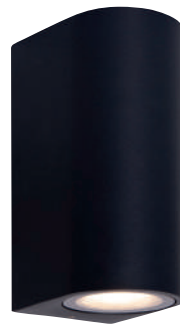

 Negro	 2 x GU10 (NO INCLUIDOS)	 Aluminio	 Luz bidireccional
 Ø80x68x150mm	 Sobreponer	 IP65	 GARANTÍA 5 años KULENS

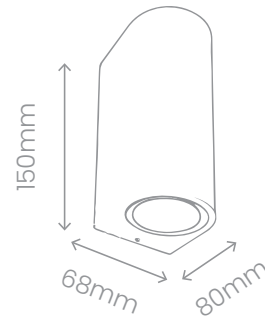

Fabricados con materiales resistentes a la intemperie como aluminio, acero inoxidable o hierro fundido, estos dispositivos garantizan durabilidad y protección contra las condiciones climáticas adversas

## EXTERIOR ARBOTANTES

Av. Circunvalación Agustín Yáñez 1118, Col. Moderna, Guadalajara, Jal. C.P. 44190



Disfruta de una iluminación más cómoda y estética, creando ambientes más agradables y mejorando la distribución de la luz, dándole un acabado elegante y sofisticado, perfecto para espacios residenciales y comerciales.



## LGR18AB



 Blanco	 GU10 (NO INCLUIDO)	 Fundido en Alum.	 Luz direccional
 Ø80x68x80mm	 Sobreponer	 IP65	 GARANTÍA 5 AÑOS KULENS

## LGR18AN



 Negro	 GU10 (NO INCLUIDO)	 Fundido en Alum.	 Luz direccional
 Ø80x68x80mm	 Sobreponer	 IP65	 GARANTÍA 5 AÑOS KULENS

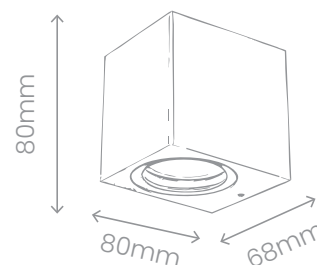

## EXTERIOR ARBOTANTES

Av. Circunvalación Agustín Yáñez 1118, Col. Moderna, Guadalajara, Jal. C.P. 44190



## LGR19AB



 Blanco	 2 x GU10 (NO INCLUIDOS)	 Aluminio	 Luz bidireccional
 Ø80x68x150mm	 Sobreponer	 IP65	 GARANTÍA 5 AÑOS KULENS

## LGR19AN



 Negro	 2 x GU10 (NO INCLUIDOS)	 Aluminio	 Luz bidireccional
 Ø80x68x150mm	 Sobreponer	 IP65	 GARANTÍA 5 AÑOS KULENS

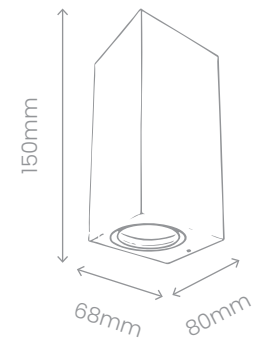

Una luminaria tipo arbotante es mucho más que una fuente de luz: es una solución integral que combina funcionalidad, seguridad, eficiencia energética y diseño. Los arbotantes ofrecen versatilidad estética y alto rendimiento, adaptándose perfectamente a cualquier necesidad de iluminación.

## EXTERIOR ARBOTANTES

Av. Circunvalación Agustín Yáñez 1118, Col. Moderna, Guadalajara, Jal. C.P. 44190



# LÁMPARAS



Cuenta con tecnología CCT (selección de color), que permite ajustarla a las necesidades de cada espacio. Las lámparas **GU10** destacan por su eficiencia energética y versatilidad, ofreciendo un bajo consumo y una larga vida útil, lo que las convierte en una inversión inteligente a largo plazo. Además, están diseñadas para garantizar una conexión segura y estable, con una instalación sencilla y rápida."

GU1053CCTA38



<b>Lumens</b>	450 lm
<b>Potencia</b>	5W
<b>Temperatura de color</b>	3000K 4000K 6000K
<b>Ángulo</b>	38°
<b>Medidas</b>	Ø50xH56mm

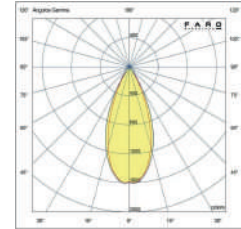

• **Aplicaciones:** Iluminación de acento en salas, vitrinas, pasillos, restaurantes y comercios.

GU1053CCTA60



<b>Lumens</b>	450 lm
<b>Potencia</b>	5W
<b>Temperatura de color</b>	3000K 4000K 6000K
<b>Ángulo</b>	60°
<b>Medidas</b>	Ø50xH56mm

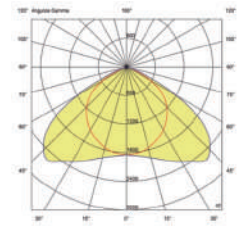

• **Aplicaciones:** Iluminación general en salas, cocinas, oficinas, pasillos, hoteles y comercios.

GU10505630KA120



<b>Lumens</b>	450 lm
<b>Potencia</b>	5W
<b>Temperatura de color</b>	3000K
<b>Ángulo</b>	120°
<b>Medidas</b>	Ø50xH56mm

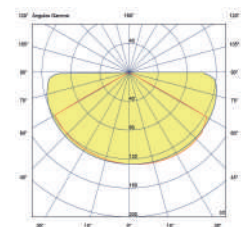

• **Aplicaciones:** Cubre grandes espacios, sin necesidad de muchas luminarias. Ideal para comercios, oficinas, hoteles y uso residencial.

